

#15838

Riverside
FURNITURE









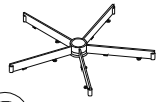

email: info@riverside-furniture.com

Belmeade
Home Office
Assembly Instructions

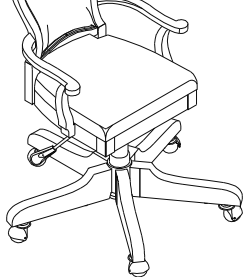
Page 1 of 2

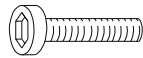
Made in Viet Nam

Components and Hardware List

Seat and Back Assembly  A 1 pc.	Chair Control Plate  B 1 pc.	Metal Base  C 1 pc.	Wood Cap  D 5 pcs.	 #15838 Round Back Uph Desk Chair
Pneumatic Cylinder & Cover  E 1 pc.	Caster  F 5 pcs.	M5/16"-18 x 1-1/8" Allen Head Bolt  G 4 pcs.	M5/16" Spring Washer  H 4 pcs.	
M5/16" *19*2mm Flat Washer  I 4 pcs.	5mm Allen Wrench  J 1 pc.	#6 x 5/8" Screw  K 10 pcs.	Be sure to check all packing material carefully for small parts, which may have come loose inside the carton during shipment. To prevent scratches or damage, assemble the chair on a soft surface such as a blanket or carpet.	

STEP 1 : Fit the bottom end of the pneumatic Cylinder (E) into center of the Metal Base Frame as shown. Press down firmly on the Pneumatic Cylinder to secure.

STEP 2 : Press the caster (F) into the holes of the Metal Base Frame.

STEP 3 : Place the Wood Base Cap (D) on top of each leg of the Metal Base Frame (C) and Assemble them by using screws (K)

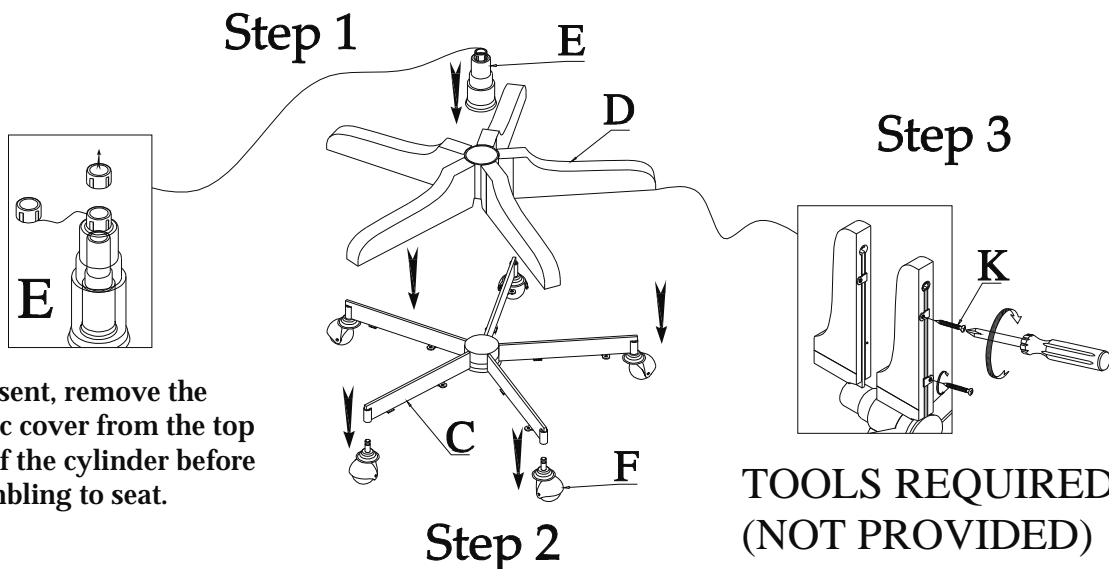

If present, remove the plastic cover from the top end of the cylinder before assembling to seat.

#15838

Riverside
FURNITURE

email: info@riverside-furniture.com

Belmeade
Home Office
Assembly Instructions

Page 2 of 2

Made in Viet Nam

STEP 4 : Attach the Seat Control (B) to the of the Chair Seat & Back (A) with Flat Washers (I), Spring Washer (H) and Allen Head Bolts (G) as shown. Tighten with the Allen Key.

STEP 5 : Fit the top of the Pneumatic Cylinder into the Seat Control. Sit on the seat to secure assembly.

Note: To prevent possible damage to some types of flooring, never roll casters on unprotected hardwood or vinyl flooring.

The lift mechanism is in a locked position for shipping . To unlock, pull straight out on the handle, and then the lift cylinder can be activated by lifting the handle.

Step 4

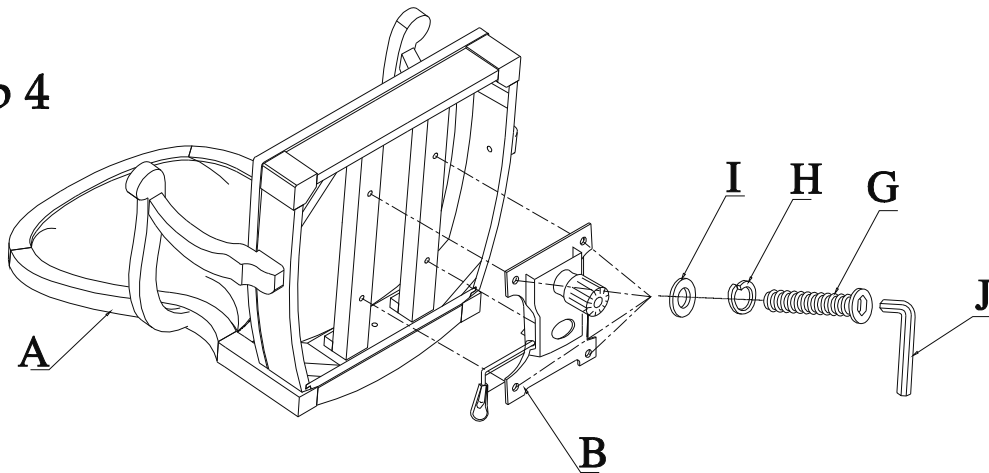

Step 5

