

**Components and Hardware List**

**Table Top**

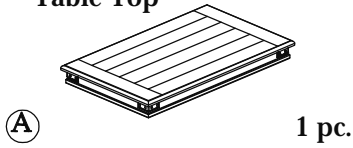

**Leg**

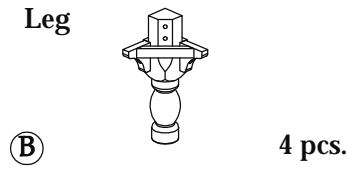

**Long Metal Stretcher**

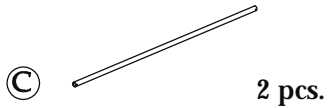

**Short Metal Stretcher**

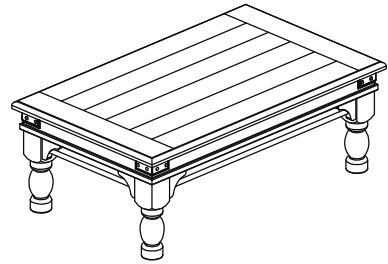
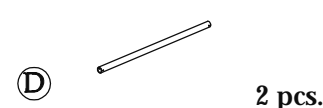

**#27302**  
**COCKTAIL TABLE**

**M5/16" x 1-3/4" Allen Head Bolt**

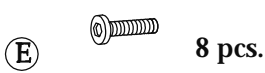

**M5/16" Spring Washer**



**M5/16" Flat Washer**

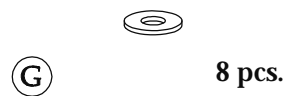

**5mm Allen Wrench**

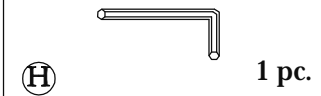

Be sure to check all packing material carefully for small parts, which may have come loose inside the carton during shipment. To prevent possible scratches or damage, this product should be assembled on a soft surface such as a blanket or carpet.

**Step 1**

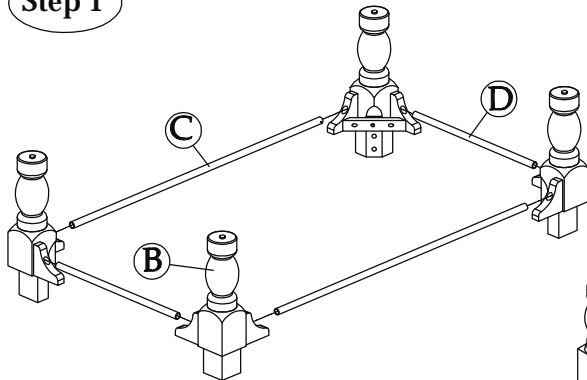

**Step 2**

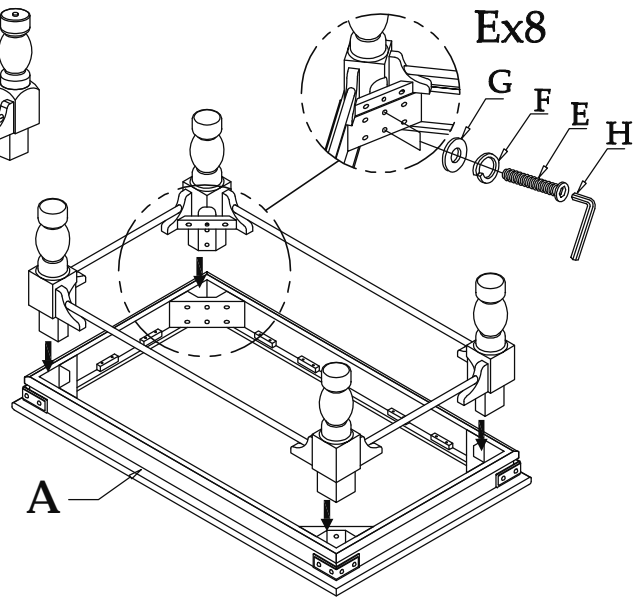

**Step 3**

