

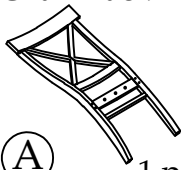

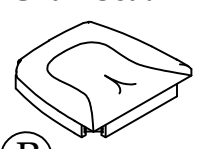



Components and Hardware List

<p>Chair Back</p>  <p>A 1 pc.</p>	<p>Chair Seat</p>  <p>B 1 pc.</p>	<p>Left/Right Legs</p>  <p>C 2 pcs.</p>	<p>Left/Right Stretchers</p>  <p>D 2 pcs.</p>
<p>5/16" - 18 x 3 3/4" Allen Head Bolt</p>  <p>E 4 pcs.</p>	<p>5/16" - 18 x 2 1/2" Allen Head Bolt</p>  <p>F 4 pcs.</p>	<p>5/16" - 18 x 1 1/2" Allen Head Bolt</p>  <p>G 2 pcs.</p>	<p>5/16" x 12mm x 3mm Spring Washer</p>  <p>H 10 pcs.</p>
<p>5/16" x 19mm x 2mm Flat Washer</p>  <p>I 10 pcs.</p>	<p>5mm Allen Wrench</p>  <p>J 1 pc.</p>	<p>#8 x 1" Wood Screw</p>  <p>K 4 pcs.</p>	

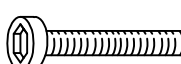
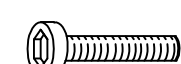
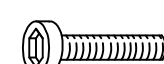

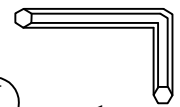
#58957
X-Back Side Chair

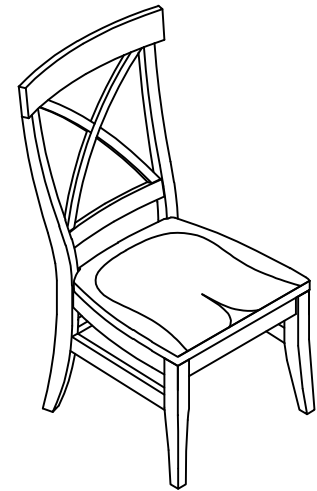
Be sure to check all packing material carefully for small parts, which may have come loose inside the carton during shipment. Separate, count and check all parts against the Components and Hardware List above. Failure to use the correct length bolts in the proper locations may result in an unsafe product and could also cause damage to the parts being assembled.

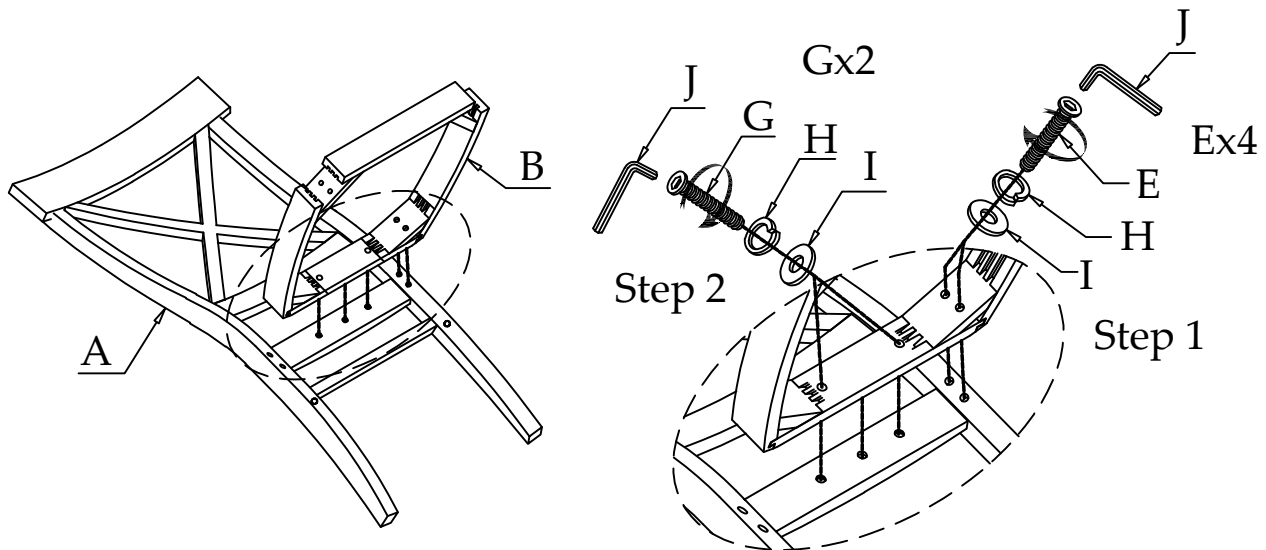

Do not fully tighten the bolts until the complete chair has been assembled. Once the complete chair is assembled, set it upright on a flat surface to level the chair. Using the provided Allen Wrench, tighten all the bolts.

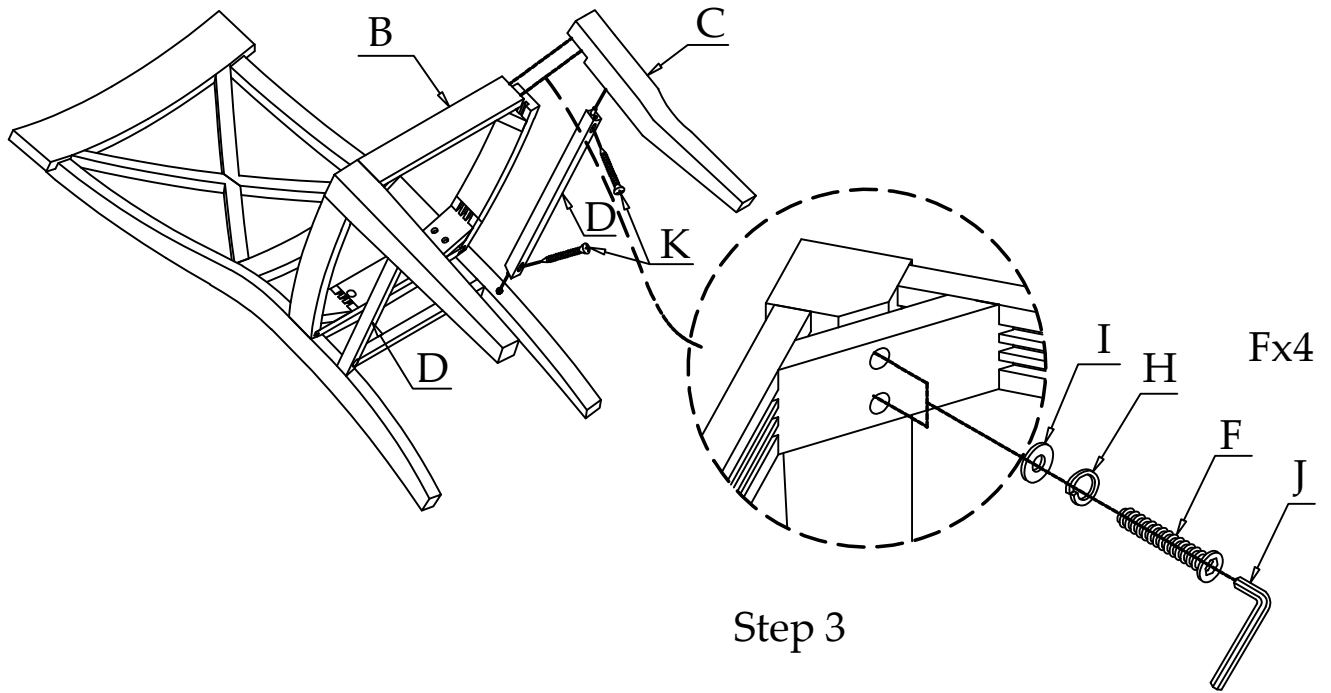

Step 3

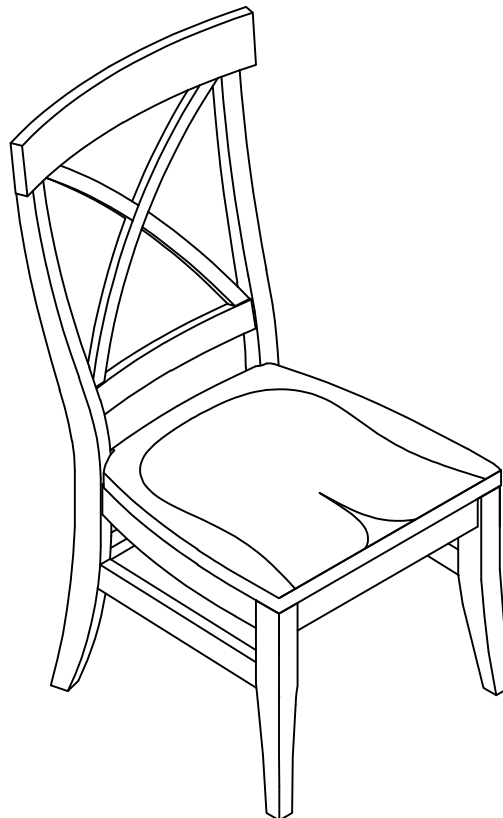

Completed Chair